

Operation Manual

P-72MX



EAGLE AMERICA SALES CORPORATION
2517 W 237th Street, Unit C
Torrance, CA 90505

ACEBIL
CAMERA SUPPORT EQUIPMENT

P-72MX

Tripod System Package

Copyright © Eagle America Sales Corporation 2011

All rights reserved. Reproduction of any part of this document including images, artwork, or writing without prior written consent of Eagle America Sales Corporation in writing is strictly prohibited.

Safety



Where there is a risk of injury, or damage to equipment, this warning symbol will appear. This equipment may cause harm if not used in accordance with this operation manual.

Before operating this equipment, please read manual for safety.

- Always maintain payload to within the maximum capacity limit.
- Ensure slide plate lock lever is firmly tightend.
- Ensure tripod is securely positioned, and all leg locks are in the locked position.
- Do not modify, or dismantle equipment, as it may cause damage, and injury.
- When using pan and tilt features, ensure the lock knobs are fully loosened.
- Always remove camera and accessories before transporting.
- Never carry tripod system by grabbing the pan arm as it may cause damage.

Technical Specifications

Weight	8kg / 17.6lb
Height	84-168cm / 33.1"- 66.1"
Payload	17kg / 37lb
Counter Balance	0+3 Steps
Pan Drag	0+3 Steps
Tilt Drag	0+3 Steps
Tilt Angle	+90/-75
Ball Diameter	100mm
Tripod Section	2 Stage
Camera Plate	Slide Plate
Slide Range	+50/-50mm
Plate Attachment	1/4" & 3/8" Screw with video pin
Spare Screw	3/8" - Screw * 2 pcs
LED level illumination	Yes

Contents

Safety	3
Technical Specifications	3
Components	5
Counterbalance	6
Operation	
Setting up the Tripod	7
Mounting the Camera	8
Balancing	9
Pan and Tilt	10
Further Information	11

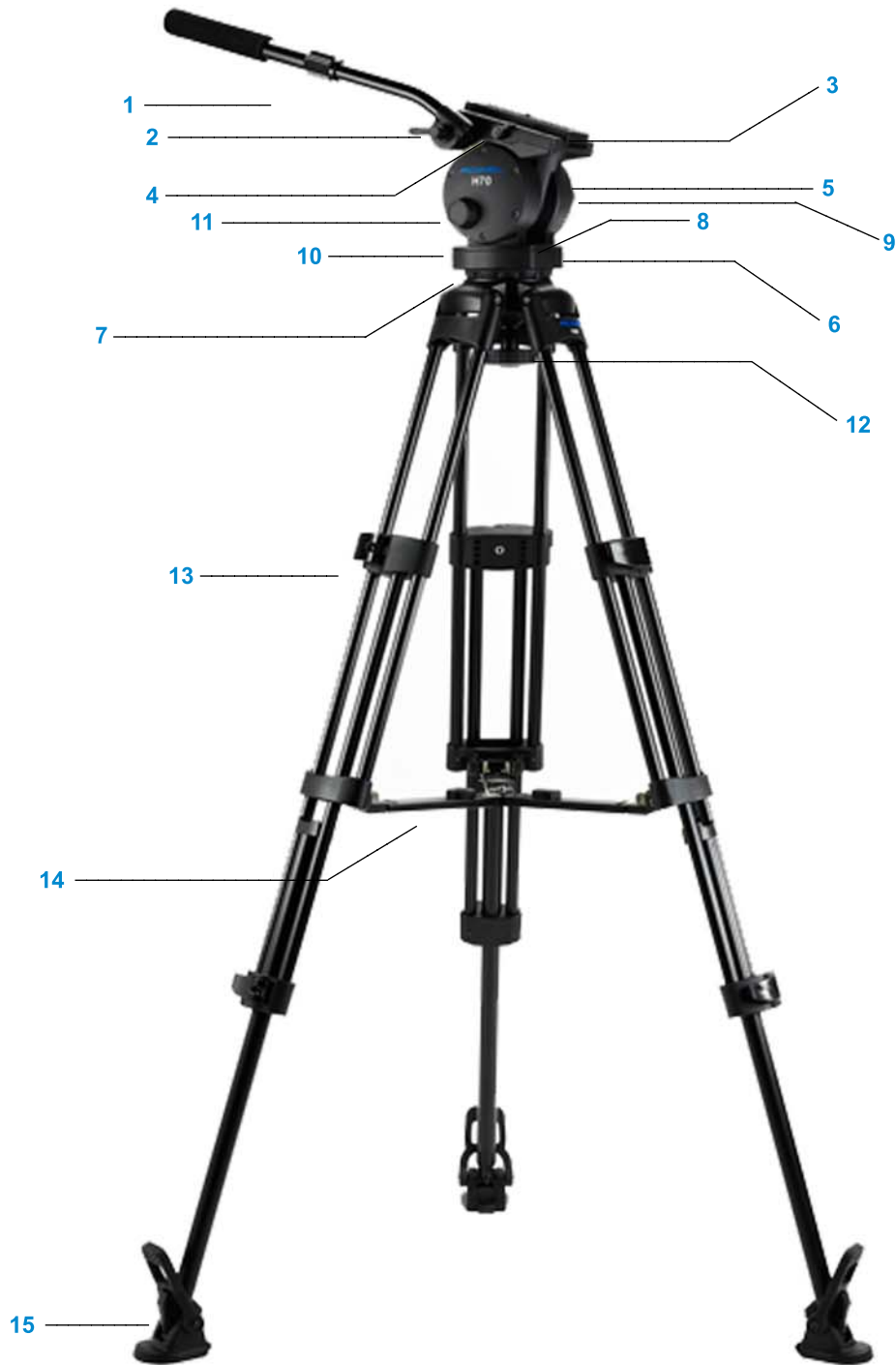

- 1 - Pan Bar (PB-5)
- 2 - Pan Bar Mount
- 3 - Slide Plate
- 4 - Slide Plate Lock Knob
- 5 - Tilt Lock Knob
- 6 - Pan Lock Knob
- 7 - Ball Leveler

- 8 - Bubble Level w/ LED auto
- 9 - Tilt Drag Knob
- 10 - Pan Drag Knob
- 11 - Counter Balance Knob
- 12 - Ball Leveler Fixing Handle
- 13 - Leg Lock
- 14 - Mid Spreader (MS-5)
- 15 - Rubber Feet (RF-3)

P-72MX

Counter Balance

The definitive way to find the most accurate counterbalance between camera/accessories and a tripod head is to actually mount the camera on the head. However, you can use this counterbalance chart to get a rough idea of the correct counterbalance.

The vertical axis of the chart depicts the height of the gravitational center and the horizontal axis is load weight (total weight of the camera and accessories). Based on the combination of these two elements, you can find a suitable tripod head for your camera.

When a standard lens, microphone and battery are used, the normal height of the gravitational center is approximately 125mm / 4.9"(for a shoulder type camera), 100mm / 3.9" (semi-shoulder) and 75mm / 3.0" (hand-held). The height of the gravitational center will not shift much even when a different lens or a different battery is used on the back of the camera. Please be aware that attaching a light or a monitor on top of the camera will shift the center of gravity.

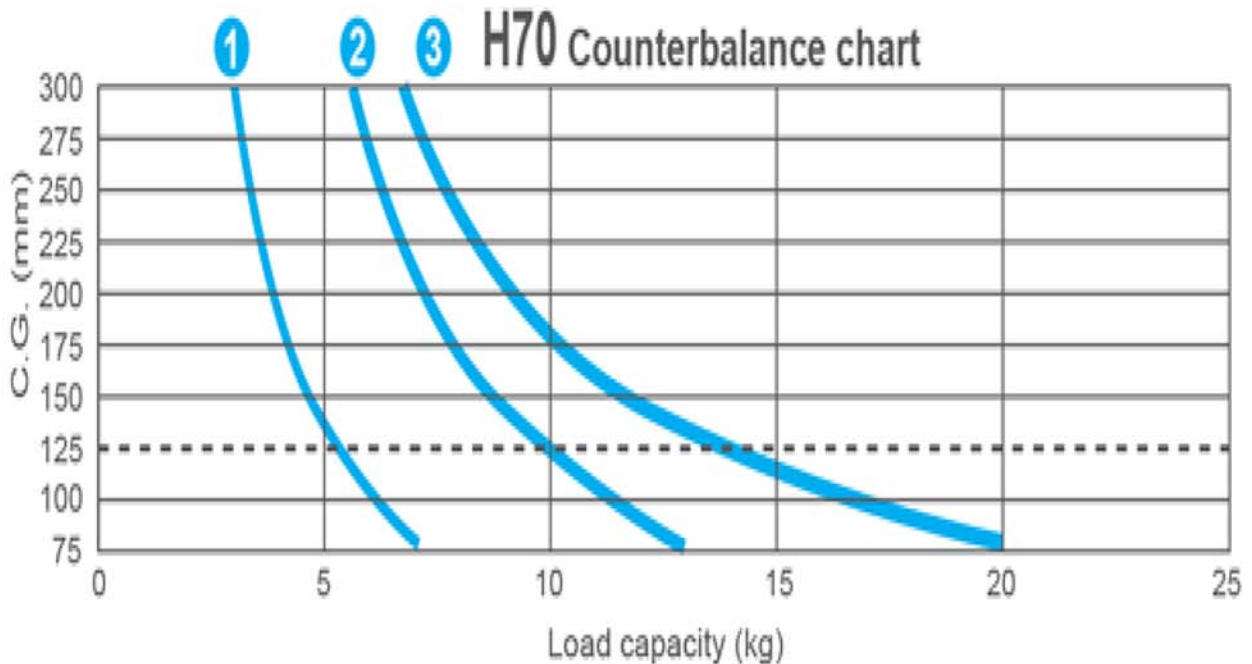

Setting up the tripod.

1. Release tripod holding hook.
2. Extend tripod to desired height.
 - ① Unlock upper leg locks while holding the tripod.
 - ② Adjust legs to desired height, and re-engage leg locks. Repeat steps with lower leg locks if desired.
3. Unfold tripod, and ensure spreader is extended and fully horizontal.
4. Adjust pan arm position.
 - ① Loosen pan arm lock knob, set to desired position..
 - ② Tighten pan arm lock knob firmly.

1.



2.



3.



4.



Mounting the camera.



Load capacity is 17kg / 37lbs. - Do exceed the load capacity as it may cause damage to equipment or injury.
When mounting and removing camera, ensure the tilt lock knob is firmly tightened.

1. Ensure tilt lock knob is tightened.
2. Loosen the ball leveler fixing handle, level the head using the bubble level, and tighten the ball leveler fixing handle securely.
3. Remove the slide plate.
 - ① Loosen the slide plate lock lever.
 - ② Press slide plate safety lock to release slide plate.
 - ③ Pull slide plate out.
4. Mount the camera to the slide plate.
Align the camera screw and video boss with the camera, and tighten camera screw securely.
5. Mount camera and slide plate to the tripod head.
With camera mounted, insert slide plate back into the tripod head.
Tighten slide plate lock lever securely, for final step.



Balancing

When balanced correctly, it will take a minimum amount of effort to tilt the head smoothly.

When perfect balance is achieved, the head and payload can be set to any tilt angle, and will maintain its position without the operator holding it (hands free).

Ensure all accessories, including pan arms are mounted prior to balancing.



Prevent the payload from free falling when tilt lock knob is loosened.

Failure to secure the camera and payload may result in damage to equipment and injury.

While securing the payload, loosen the tilt lock knob, and adjust the slide plate position until balance is achieved.

When slide plate is locked into position, use the continuous counter balance adjustment lever to add or reduce counter balance until perfect balance is achieved.



Counter Balance Adjustment

Pan and Tilt

The head can be locked at any chosen position by using the pan and tilt lock knobs.
To lock the head, turn lock knob fully clockwise.
To unlock the head, turn lock knob fully counter-clockwise.



DO NOT use lock knobs to supplement drag, as it may cause damage to the head.

■ Panning

Unlock the pan lock knob by turning counter-clockwise fully.
Pan the head left to right as needed.
Lock into position by turning the pan lock knob clockwise fully.
Use the continuous drag control by turning drag knob to add or reduce drag.

■ Tilting

Unlock the tilt lock knob by turning counter-clockwise fully.
Tilt the head up and down as needed.
Lock into position by turning the tilt lock knob clockwise fully.
Use the continuous drag control by turning drag knob to add or reduce drag.



Further Information

For more information on products listed in this manual, visit us online:

www.acebil.com

or contact us at:

Eagle America Sales Corporation
Acebil
2517 W 237th Street, Unit C
Torrance, CA 90505

TEL: (310) 257-8886

FAX: (310) 257 8885

To view our full line of Acebil camera support equipment, visit us online:

www.acebil.com

